

# Single Seat UFO - Mark One

(Attribution-NonCommercial 3.0 Unported (CC BY-NC 3.0))



[www.sirrobo01.wordpress.com](http://www.sirrobo01.wordpress.com)

[www.sirrobo01.com](http://www.sirrobo01.com)



## Introduction

I designed the UFO MK-1 to be used with Okumarts Retro Aliens, but you should be able to use it with any kind of alien, the cockpit and chair should be able to hold any kind of 25/30mm miniature metal alien. The model isn't complex to build although the clear canopy and guns can be a little bit of a challenge. To finish off the weapons it's handy to have a couple of 3-4 mm (1/8 inch) plastic beads to stick on the ends to complete that retro laser look.

### Overview Assembly Diagram Clear Canopy

(Print 2<sup>nd</sup> page of PDF on clear transparency)

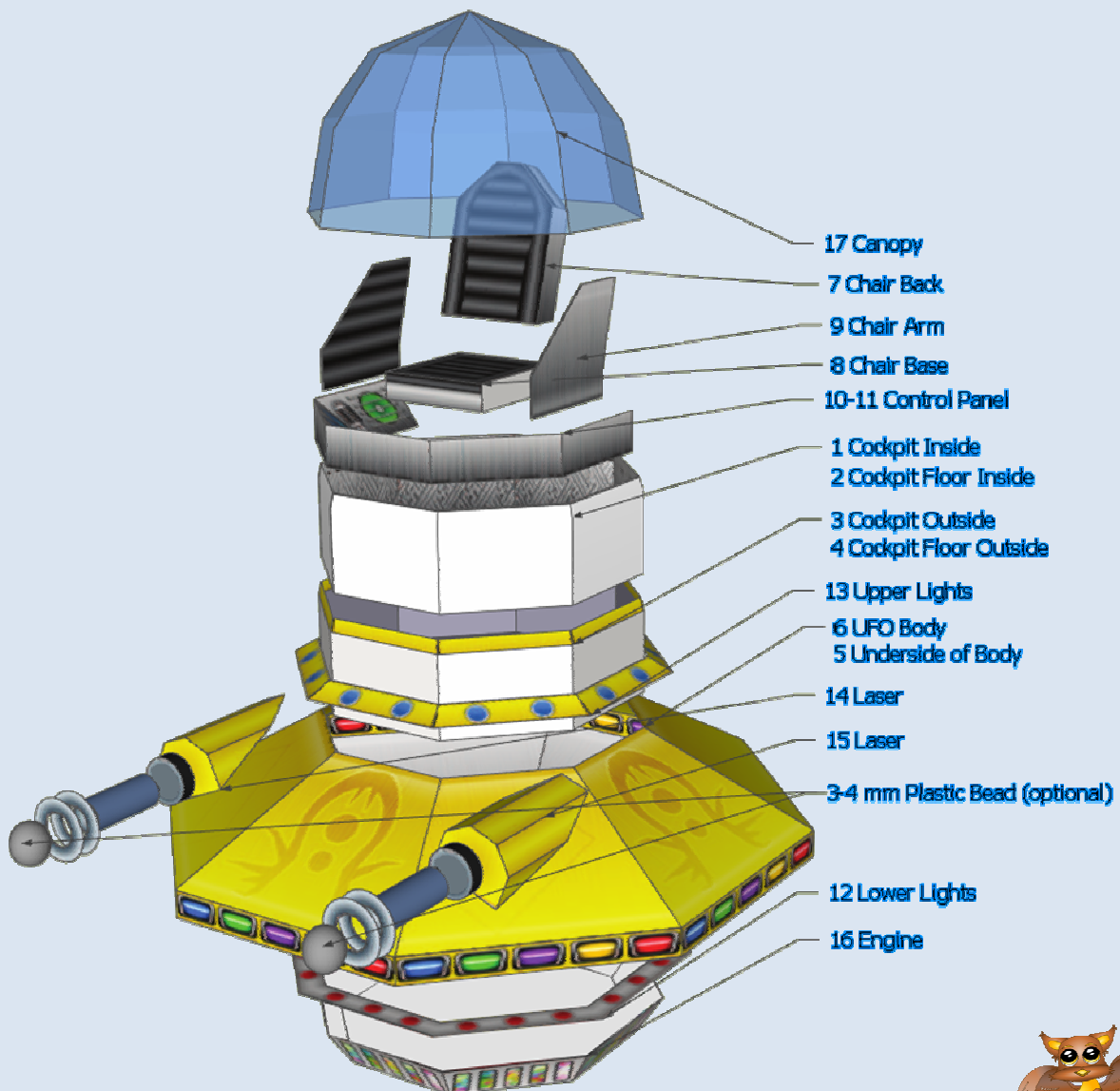

## Overview Assembly Diagram Solid Canopy

(Print 1<sup>st</sup> page of PDF only)

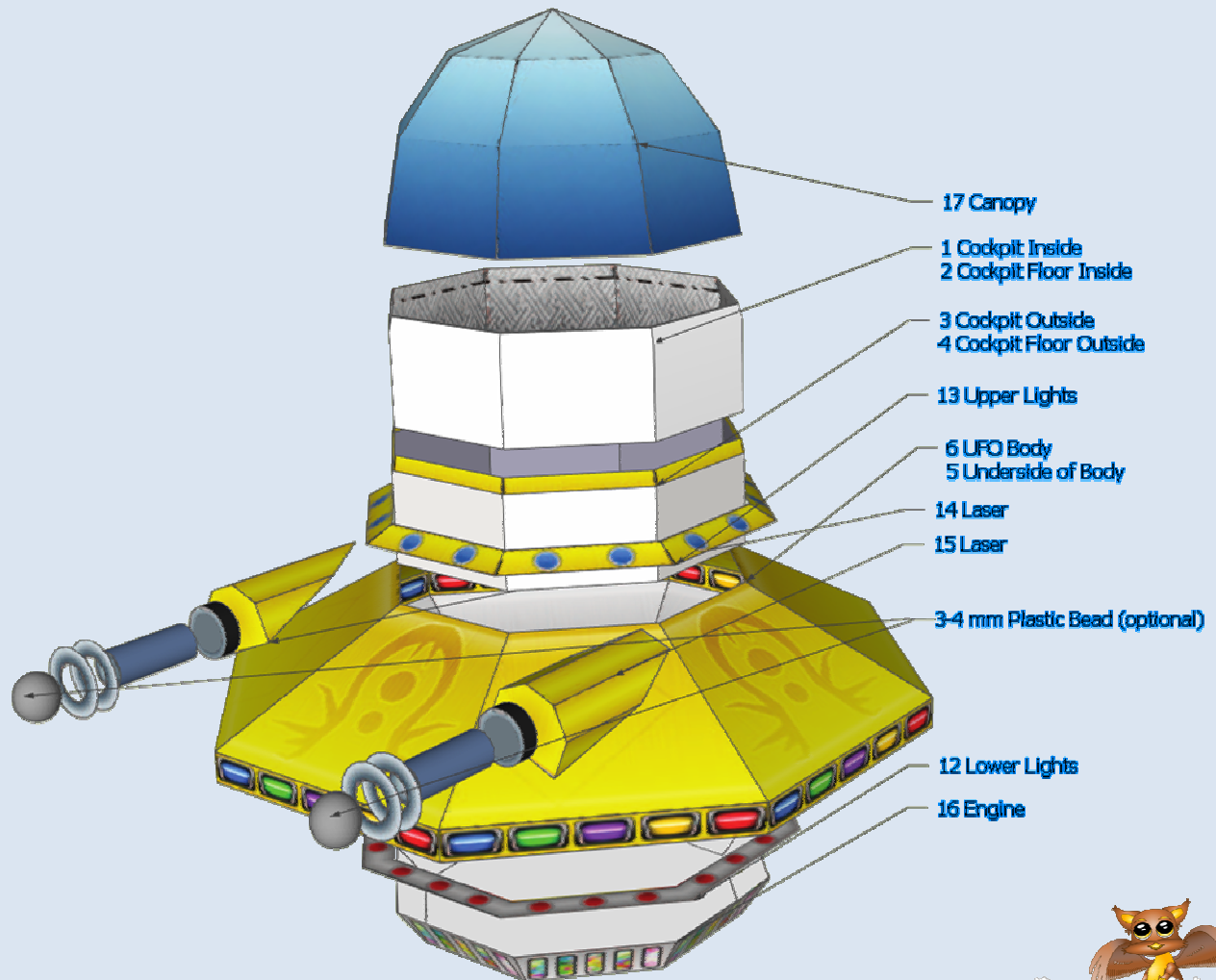

# Detailed Part Assembly

## Main Body Assembly (Part No 6)

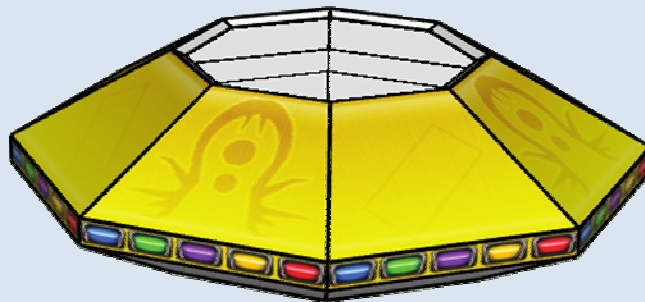
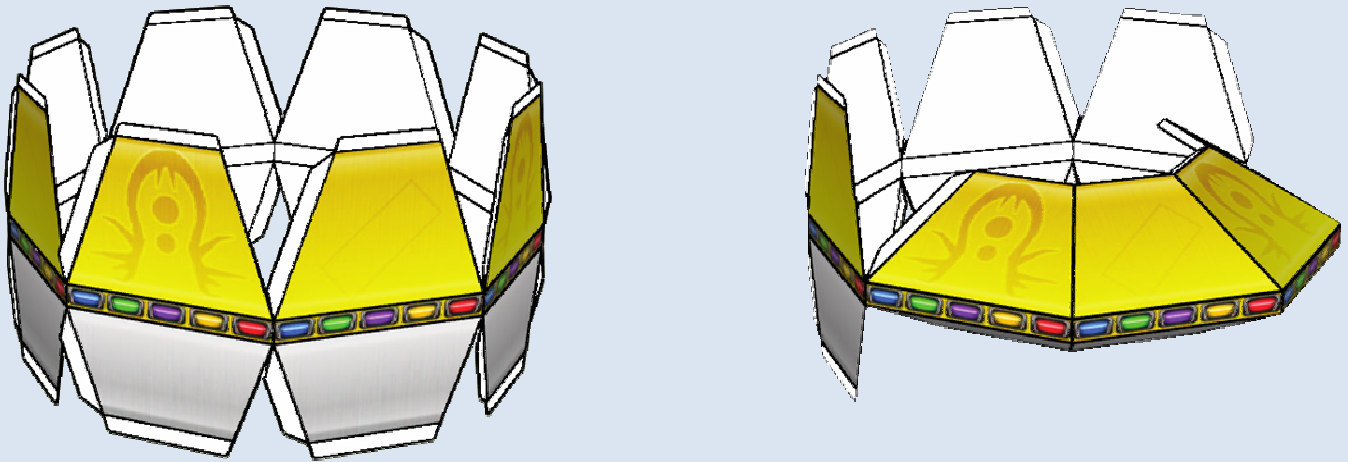

Do **not** Glue part 5 into place

## Outer Cockpit Tube (Part No 3 & 4)

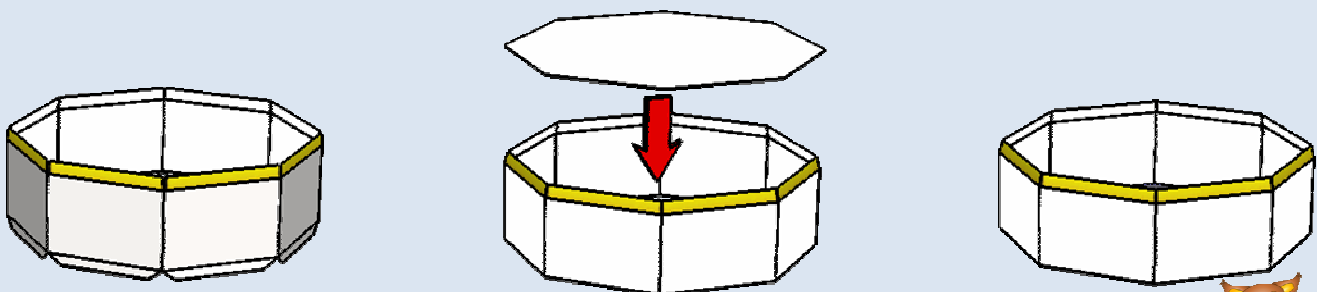

### Inner Cockpit Tube (Part No 1 & 2)

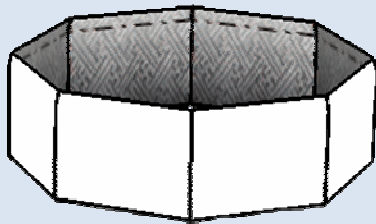

### Control Panel (Part No 10 & 11)

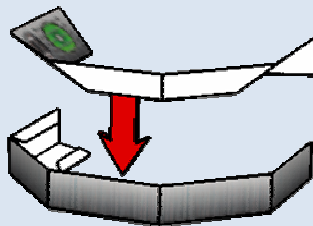
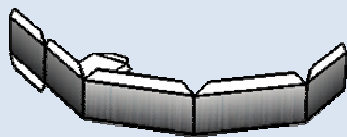

### Canopy (Part No 17)

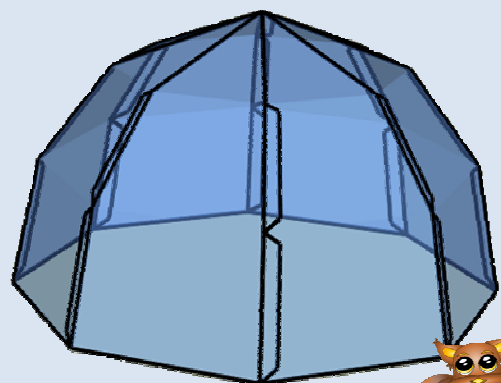
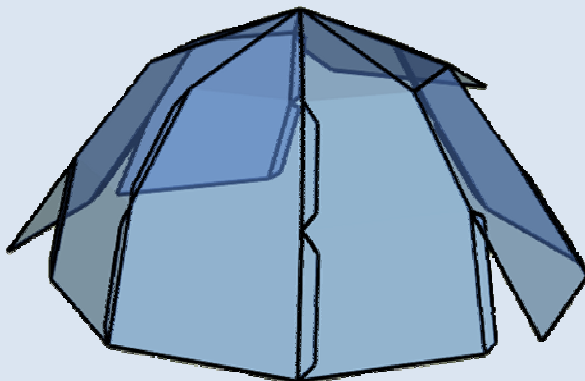

Start at front side with tabs on both sides



## Laser Assembly (Part No 14 & 15)

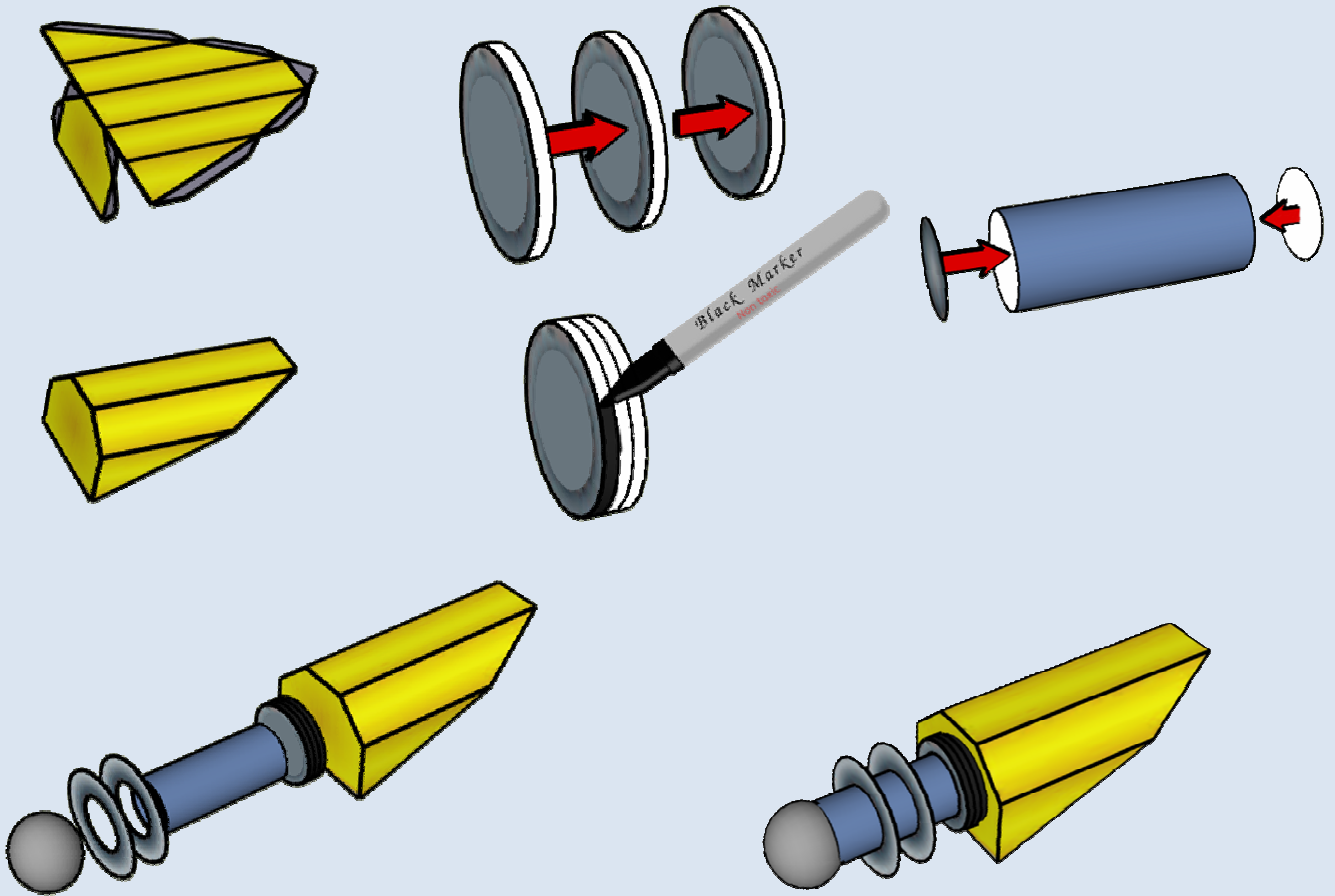

End ball is 3-4mm plastic bead. If using a plastic bead don't cap both ends of Laser tube

## Engine/Base (Part No 16)

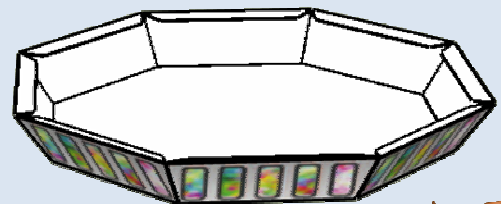

### Chair Assembly (Part No 7, 8 & 9)

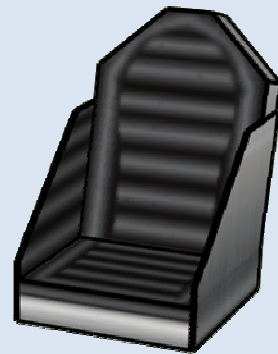
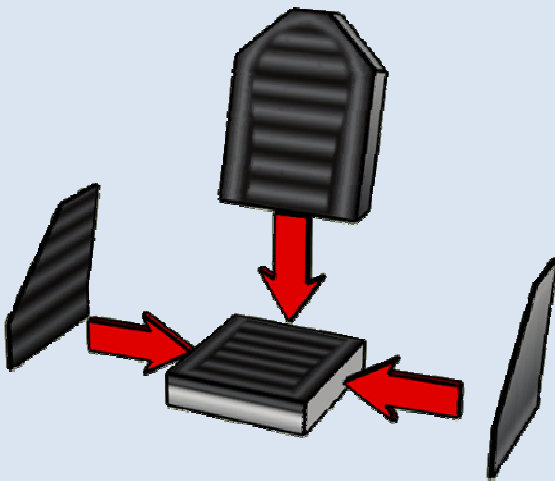
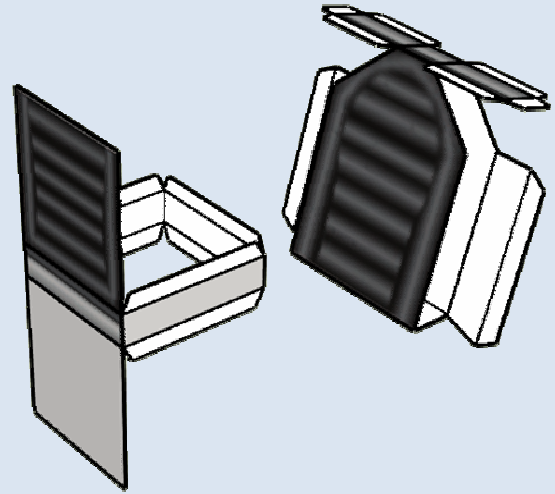
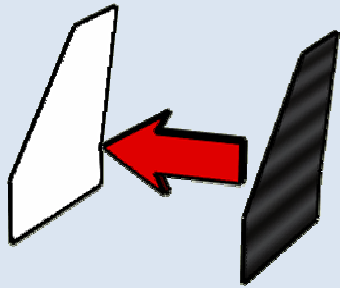

### Rest (Part No 5, 12 & 13)

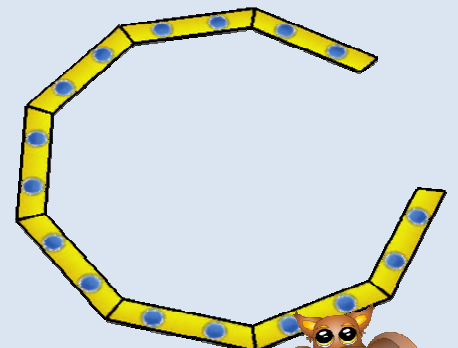
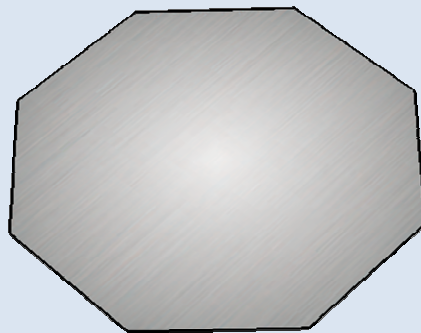
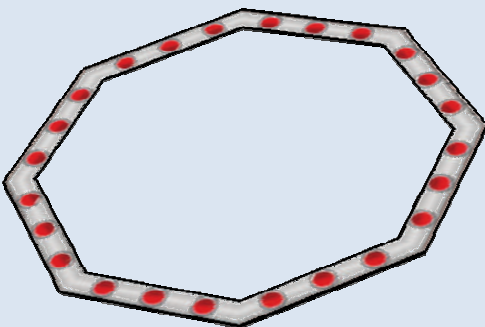

# Detailed UFO Assembly

